

**6850
2 HIGH CORNER UNIT**



Assembly Instructions.

Please read these instructions carefully before assembling the unit and where necessary refer to the enclosed Component List.

Additional Tools Required.

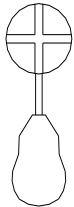

Adults Required For Assembly.



Maintenance.

Some residual dust from the manufacturing process may be apparent. Your unit may be cleaned with a damp cloth. Stubborn marks may be removed with a mild detergent or Non-abrasive cream cleaner. Examine all fasteners periodically and retighten where necessary. Care must be taken not to over tighten the fasteners.

This unit is designed to be connected to other units in this range.

This unit is designed for use indoors on a flat level surface.

An Adult Should **ALWAYS SUPERVISE PLAY!**

Please retain our address for future reference

Manufactured by:
Mike Miller Associates Ltd.,
Syke Road, Wigton. Cumbria CA7 9NS
Tel: 016973 49774/45300 Fax: 016973 45511
Email: info@twoeytoys.com
Website: www.twoeytoys.com
Registered in England No: 1425839
Registered Office: The Old Brewery, Caldbeck.
Cumbria CA7 8EW

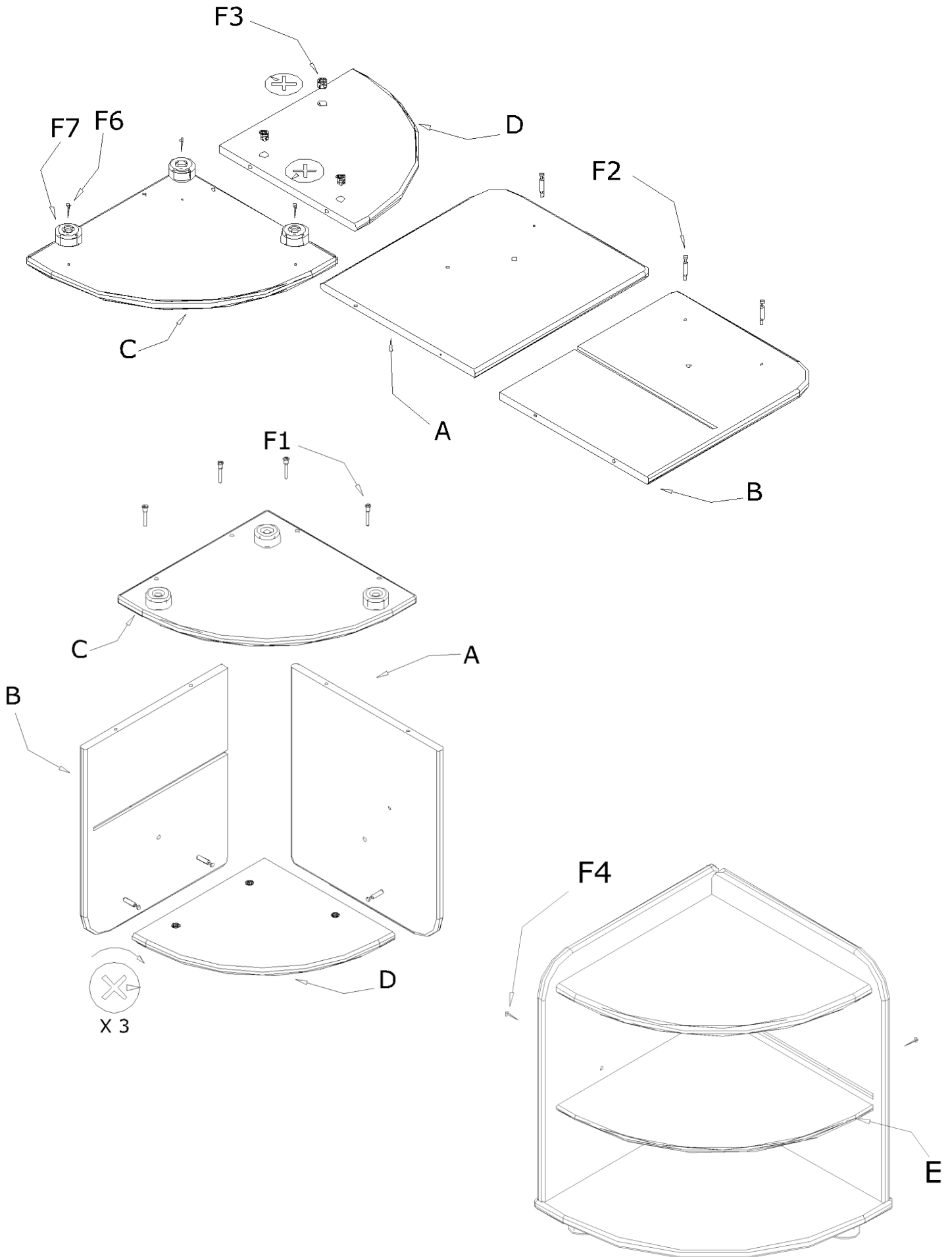

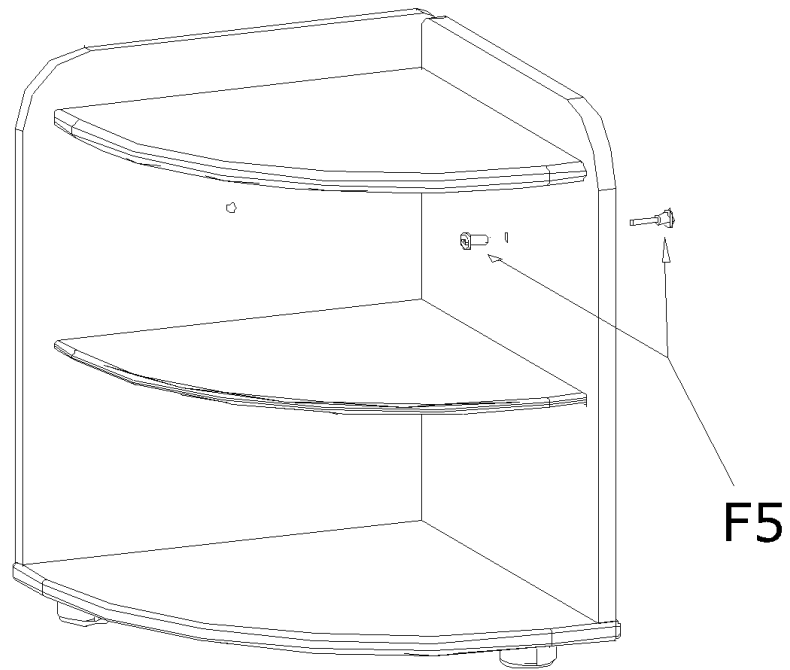

USED FOR CONNECTING UNIT TOGETHER

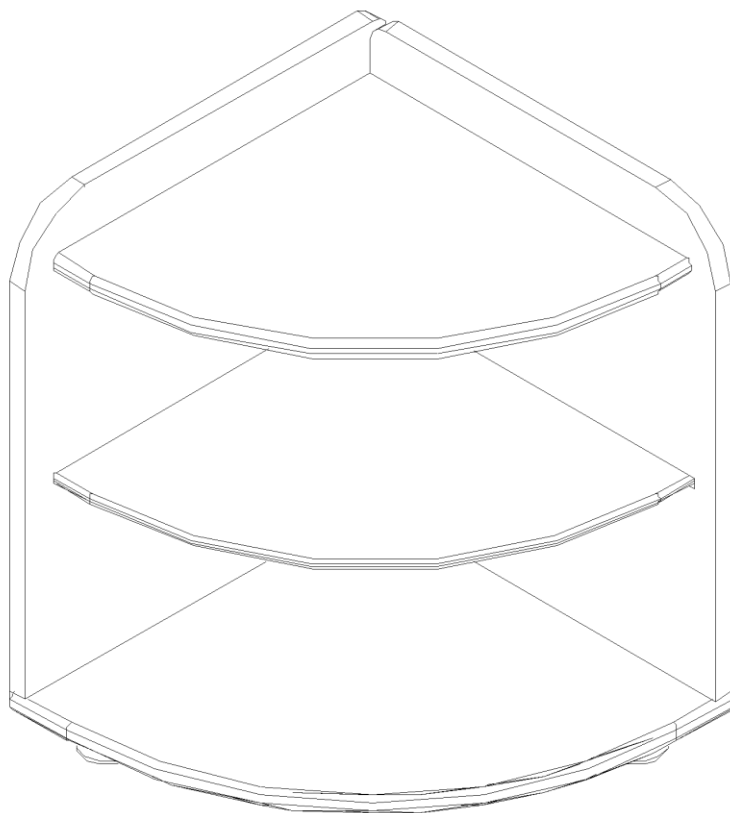

6850 - 2 HIGH CORNER UNIT (CS0000) COMPONENTS LIST

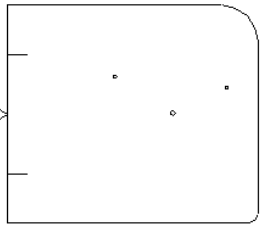

A
PN: 6850101A
QTY 1

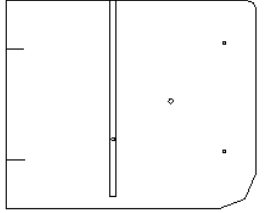

B
PN: 6850101B
QTY 1

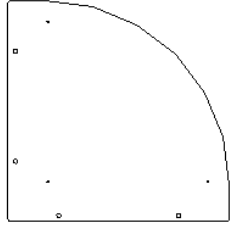

C
PN: 6850201A
QTY 1

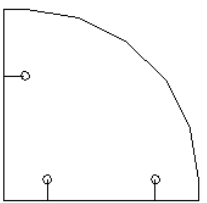

D
PN: 6850201B
QTY 1

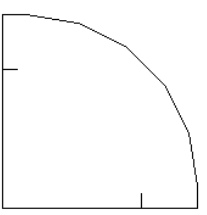

E
PN: 6850301
QTY 1

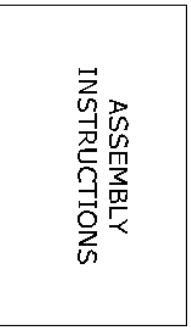

KIT



F1
SUPERJOINER
PN: FS6338SW4
QTY 4

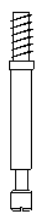

F2
MINIFIX BOLT
PN: FC3410MINI15
QTY 3



F3
MINIFIX HOUSING
PN: FC15C
QTY 3



F4
SCREW PAN HD
No.6 x 1 1/4"
PN: FS611/4P
QTY 2

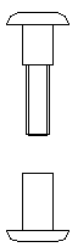

F5
BOLT & SLEEVE
M6 x 30
PN: FBM630SL
QTY 1



F6
SCREW CSK HD
No.6 x 3/4"
PN: FS63/4C
QTY 3

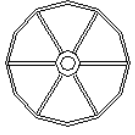

F7
CIRCULAR GLIDE 4520
PN: APGLD4520
QTY 3

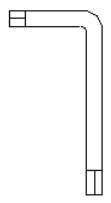

ALLEN KEY
PN: AMSW4
QTY 1